



CM-SCE-TP

TE Internal #: 6485470001

TE Internal Description: CM-SCE-1/4-4H-9

[View on TE.com >](#)



Product Compliance

[For compliance documentation, visit the product page on TE.com>](#)

EU RoHS Directive 2011/65/EU	Compliant
EU ELV Directive 2000/53/EC	Compliant
China RoHS 2 Directive MIIT Order No 32, 2016	No Restricted Materials Above Threshold
EU REACH Regulation (EC) No. 1907/2006	Current ECHA Candidate List: JUNE 2024 (241) Candidate List Declared Against: JUNE 2024 (241) Does not contain REACH SVHC
Halogen Content	Not Low Halogen - contains Br or Cl > 900 ppm.
Solder Process Capability	Not applicable for solder process capability

Product Compliance Disclaimer

This information is provided based on reasonable inquiry of our suppliers and represents our current actual knowledge based on the information they provided. This information is subject to change. The part numbers that TE has identified as EU RoHS compliant have a maximum concentration of 0.1% by weight in homogenous materials for lead, hexavalent chromium, mercury, PBB, PBDE, DBP, BBP, DEHP, DIBP, and 0.01% for cadmium, or qualify for an exemption to these limits as defined in the Annexes of Directive 2011/65/EU (RoHS2). Finished electrical and electronic equipment products will be CE marked as required by Directive 2011/65/EU. Components may not be CE marked. Additionally, the part numbers that TE has identified as EU ELV compliant have a maximum concentration of 0.1% by weight in homogenous materials for lead, hexavalent chromium, and mercury, and 0.01% for cadmium, or qualify for an exemption to these limits as defined in the Annexes of Directive 2000/53/EC (ELV). Regarding the REACH Regulation, the information TE provides on SVHC in articles for this part number is based on the latest European Chemicals Agency (ECHA) 'Guidance on requirements for substances in articles' posted at this URL: <https://echa.europa.eu/guidance-documents/guidance-on-reach>

Compatible Parts



TE Part # 1-2186500-1
T3212-PRINTER



TE Part # 1-2186502-1
T3224-PRINTER



TE Part # 1-2186503-1
T3224-SWARE-PRINTER

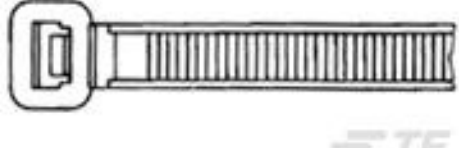

TE Part # 4-160968-1
CABLE TY 134X2.6 NAT

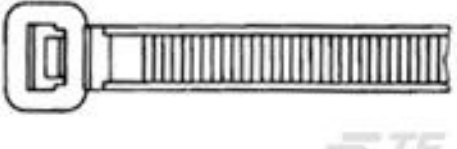

TE Part # 4-160968-2
CABLE TY 134X2.6 BLACK

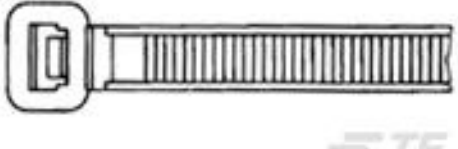

TE Part # 4-160971-2
CABLE TY 140X3.6 BLACK

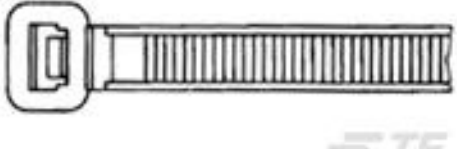

TE Part # 4-160975-2
CABLE TY 200X4.8 BLA

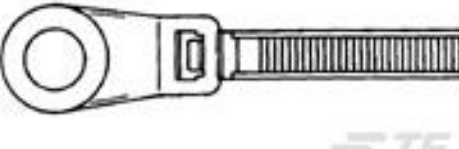

TE Part # 2-100715-1
CABLE TY 150X3,6NAT

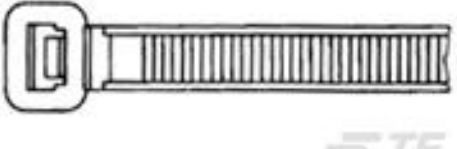

TE Part # 2-160975-1
CABLE TY 200X4.8 NAT

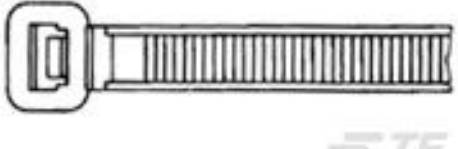

TE Part # 4-160975-1
CABLE TY 200X4.8 NAT

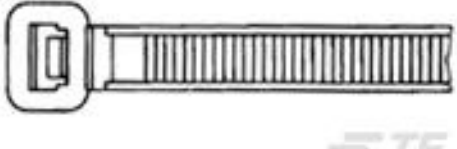

TE Part # 2-160977-2
CABLE TY 290X4.8 BLA

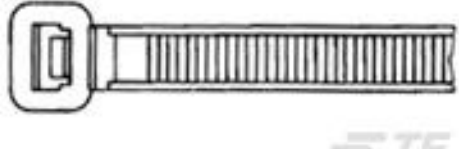

TE Part # 2-160978-2
CABLE TY 360X4,8BLA

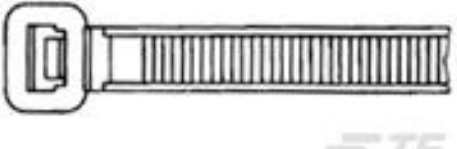

TE Part # 2-160968-1
FOAC CABLE TY NATURAL 134X2.6



TE Part # 1-2186501-1
T3212-SWARE-PRINTER

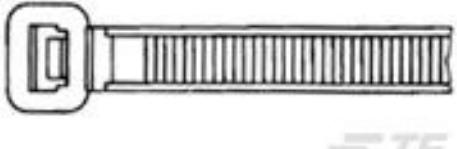

TE Part # 2-160968-2
CABLE TY 134X2.6 BLACK

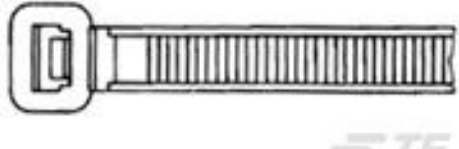

TE Part # 2-160971-2
FOAC CABLE TY BLACK 140X3.6



TE Part # 4-160970-1
CABLE TY 200X2.6 NAT

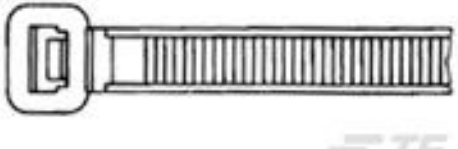

TE Part # 4-160996-2
CABLE TY 200X3.6 BLA

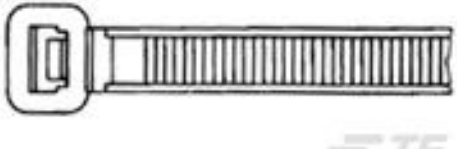

TE Part # 2-160995-2
CABLE TY 430X4.8 BLA

Also in the Series | **CM-SCE-TP**

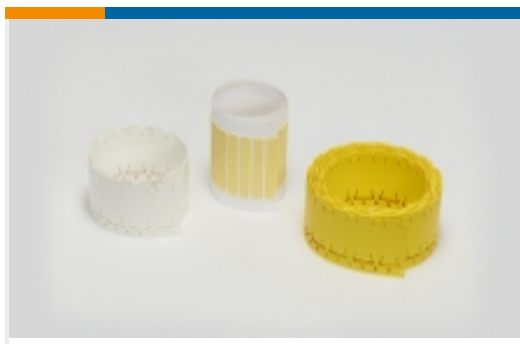

Printable Tags(12)

Customers Also Bought



TE Part #9-1393104-3
KRPA-14DY-24=KRPA



TE Part #070663-000
55A1812-22-9-9CS2275



TE Part #YDTS20W25-35SEV001
RECP ASSY

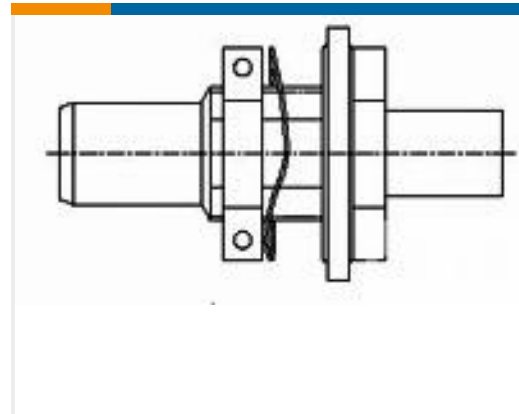

TE Part #601155-000
D-621-0012



TE Part #0076930001
CM-SCE-1/2-4H-9



TE Part #1-59907-5
HYP8 15FT HAND CTRL



TE Part #CTJ720K01B
MODULE ASSY



TE Part #E18496-000
TTVF075WE-100

Documents

Datasheets & Catalog Pages

[CM-SCE Technical Datasheet](#)

English

Product Specifications

[CABLE MARKER INSTALLATION GUIDE](#)

English

[Product Specification](#)

English