

Surface Mount Schottky Rectifier

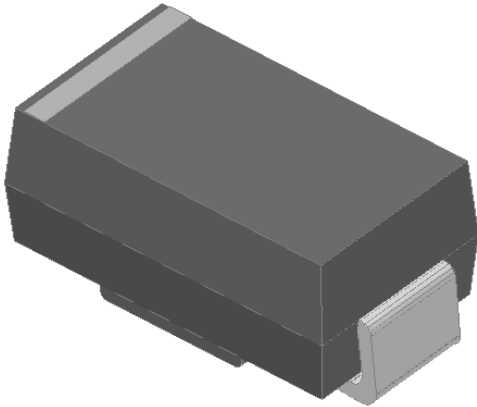

Features

- Low profile package
- Ideal for automated placement
- Guardring for overvoltage protection
- Low power losses, high efficiency
- High forward surge capability
- Meets MSL level 1, per J-STD-020, LF maximum peak of 260 °C
- Part no. with suffix "Q" means AEC-Q101 qualified

Typical Applications

For use in low voltage high frequency inverters, freewheeling, DC/DC converters, automotive and polarity protection applications.

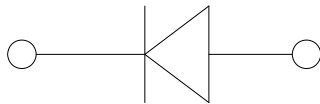

Mechanical Data

- **Package:** DO-214AC (SMA)
Molding compound meets UL 94 V-0 flammability rating, RoHS-compliant, halogen-free
- **Terminals:** Tin plated leads, solderable per J-STD-002 and JESD22-B102
- **Polarity:** Cathode line denotes the cathode end

■ Maximum Ratings ($T_a=25^\circ\text{C}$ Unless otherwise specified)

PARAMETER	SYMBOL	UNIT	SS32AQ	SS33AQ	SS34AQ
Device marking code			SS32A	SS33A	SS34A
Repetitive peak reverse voltage	V_{RRM}	V	20	30	40
Maximum RMS voltage	V_{RMS}	V	14	21	28
Maximum DC blocking voltage	V_{DC}	V	20	30	40
Maximum average forward rectified current at T_L (Fig.1)	I_O	A	3.0		
Surge(non-repetitive)forward current @60Hz half-sine wave, 1 cycle, $T_J=25^\circ\text{C}$	I_{FSM}	A	80		
Voltage rate of change (rated V_R)	dV/dt	V/ μs	10000		
Storage temperature	T_{stg}	$^\circ\text{C}$	-55 ~+150		
Junction temperature	T_J	$^\circ\text{C}$	-55 ~+150		

■ Electrical Characteristics ($T_a=25^\circ\text{C}$ Unless otherwise specified)

PARAMETER	SYMBOL	TEST CONDITIONS		TYP	MAX	UNIT
Instantaneous forward voltage	V_F	$I_F=3A$	$T_J=25^\circ\text{C}$	0.48	0.5	V
			$T_J=125^\circ\text{C}$	0.41	0.45	
Reverse current	I_R	Rated V_R	$T_J=25^\circ\text{C}$	15	100	μA
			$T_J=125^\circ\text{C}$	-	30	mA
Typical junction capacitance	C_J	$V_R=4V, f=1\text{MHz}$		150	-	pF



SS32AQ THRU SS34AQ

■ Thermal Characteristics ($T_a=25^\circ\text{C}$ Unless otherwise specified)

PARAMETER	SYMBOL	UNIT	SS32AQ	SS33AQ	SS34AQ
Thermal Resistance	$R_{\theta J-A}$	$^\circ\text{C/W}$	55 ⁽¹⁾		
	$R_{\theta J-L}$		17 ⁽¹⁾		

Note

(1) Thermal resistance from junction to ambient and from junction to lead mounted on P.C.B. with 0.2" x 0.2" (5.0 mm x 5.0 mm) copper pad areas

■ Characteristics (Typical)

Fig.1: Forward Current Derating Curve

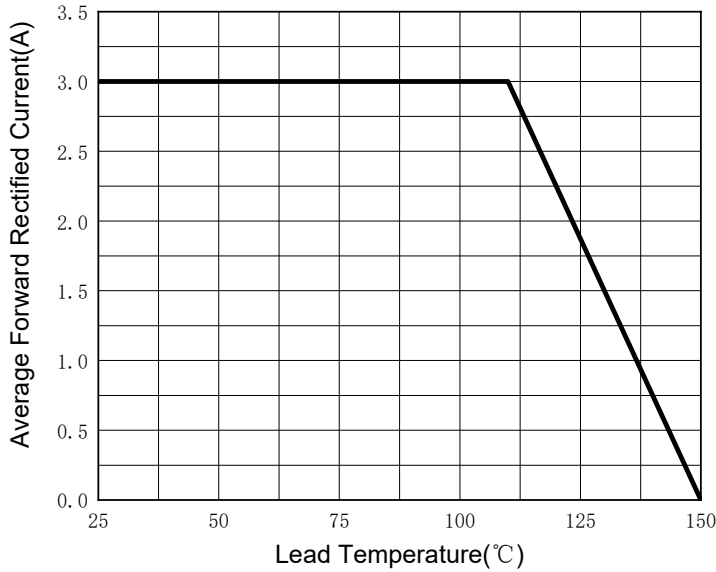

Fig.2: Maximum Non-Repetitive Peak Forward Surge Current

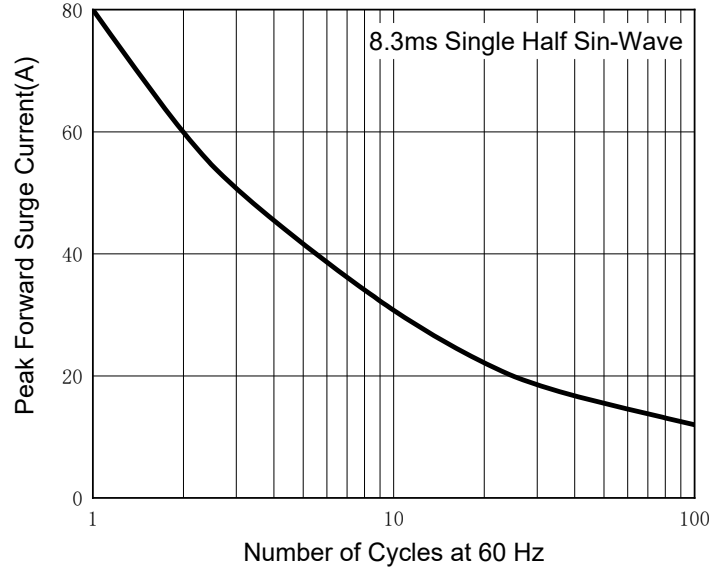

Fig.3: Typical Instantaneous Forward Characteristics

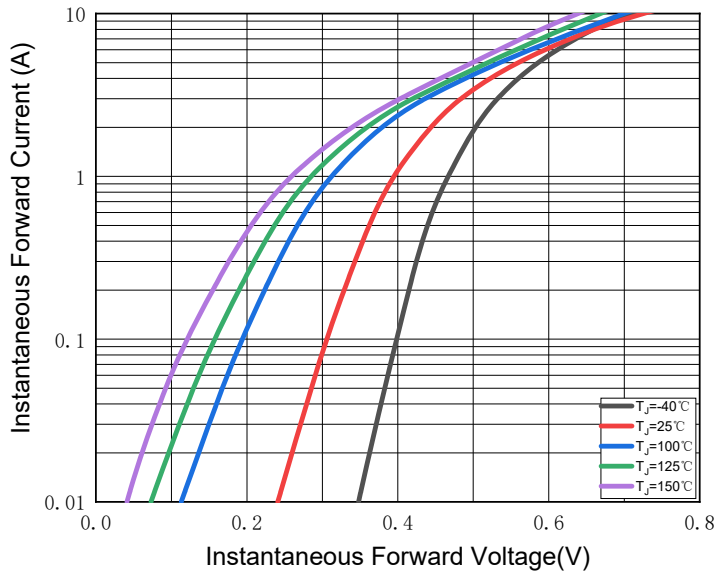
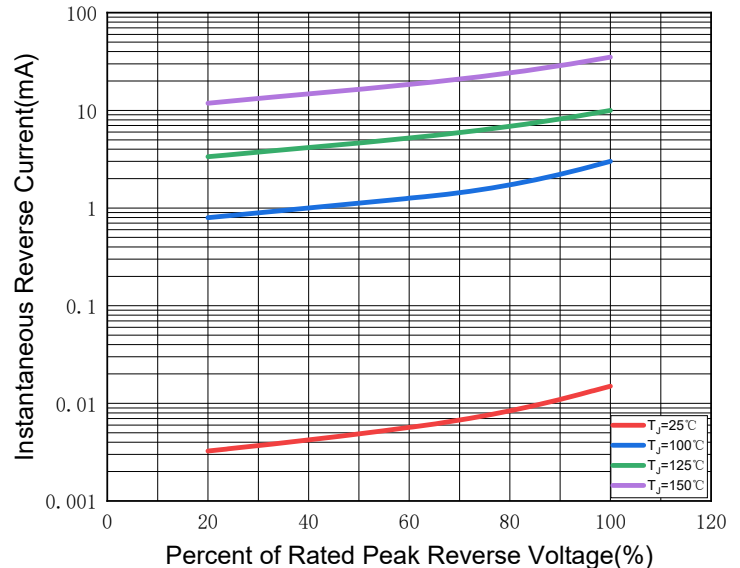

Fig.4: Typical Reverse Leakage Characteristics



■ Ordering Information (Example)

PREFERRED P/N	PACKAGE CODE	UNIT WEIGHT(g)	MINIMUM PACKAGE(pcs)	OUTER CARTON QUANTITY(pcs)	DELIVERY MODE
SS32AQ-SS34AQ	F2	Approximate 0.067	7500	120000	13" reel



SS32AQ THRU SS34AQ

■ Outline Dimensions

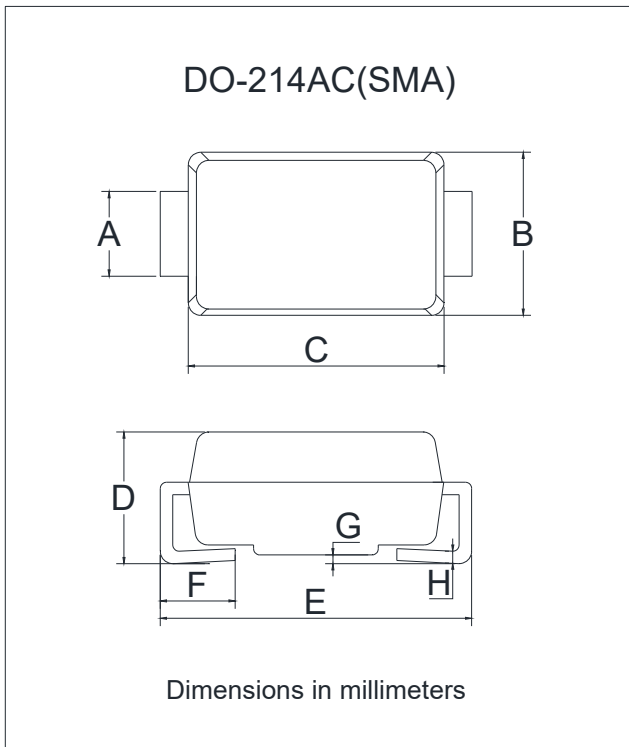

DO-214AC(SMA)		
Dim	Min	Max
A	1.25	1.58
B	2.40	2.83
C	4.06	4.75
D	1.90	2.30
E	4.93	5.28
F	0.76	1.41
G	0.08	0.20
H	0.15	0.31

■ Suggested Pad Layout

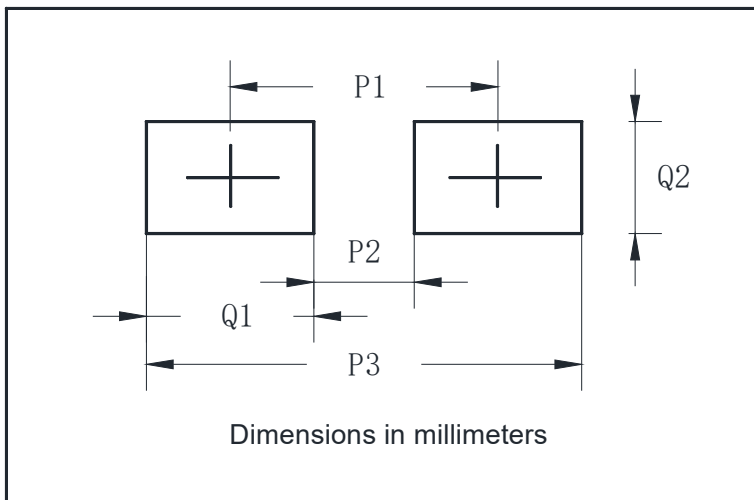

DO-214AC(SMA)	
Dim	Millimeters
P1	4.00
P2	1.50
P3	6.50
Q1	2.50
Q2	1.70



SS32AQ THRU SS34AQ

Disclaimer

The information presented in this document is for reference only. Yangzhou Yangjie Electronic Technology Co., Ltd. reserves the right to make changes without notice for the specification of the products displayed herein to improve reliability, function or design or otherwise.

The product listed herein is designed to be used with automotive electronics, are not designed for use in medical, lifesaving, lifesustaining, or military, Yangjie or anyone on its behalf, assumes no responsibility or liability for any damages resulting from such improper use of sale.

This publication supersedes & replaces all information previously supplied. For additional information, please visit our website [http:// www.21yangjie.com](http://www.21yangjie.com) , or consult your nearest Yangjie's sales office for further assistance.